

AS64AM10N-A

EN Instruction Sheet
TR Bilgi Dökümanı
TW 安裝說明
CN 安装说明



5014035303
2024-03-01



www.deltaww.com



EN This is an OPEN TYPE module and therefore should be installed in an enclosure free of airborne dust, humidity, electric shock and vibration. The enclosure should prevent non-maintenance staff from operating the device (e.g. key or specific tools are required for operating the enclosure) in case danger and damage on the device may occur. If the equipment is used in a manner not specified by the manufacturer, the protection provided by the equipment may be impaired. For any repair or maintenance needs, please contact us.

FR Ceci est un module ouvert et il doit donc être installé dans un coffret à l'abri des poussières, des vibrations et ne pas être exposé aux chocs électriques. Le boîtier ou l'armoire doit éviter toute action d'un personnel autre que celui affecté à la maintenance de l'appareil (par exemple, clefs, outils spécifiques pour l'ouverture du coffret), ceci afin d'éviter tout accident corporel ou endommagement du produit.

TR Bu ürün AÇIK TİP bir modül olup toz, rutubet, elektrik şoku ve titreşimden uzak kapalı yerlerde muhafaza edilmelidir. Yanlış kullanım sonucu ürünün zarar görmesini önlemek için yetkili olmayan kişiler tarafından ürüne müdahale edilmesini önleyecek koruyucu önlemler alınmalıdır. (Ürünün bulunduğu panoya kilit konulması gibi). Ürün, üretici tarafından belirtilmeyen bir şekilde kullanılırsa, ekipmanın sağladığı koruma bozulabilir. Herhangi bir onarım veya bakım ihtiyaçlarınız için lütfen bizimle iletişime geçin.

TW 本機為開放型 (OPEN TYPE) 機種，因此使用者使用本機時，必須將其安裝於具防塵、防潮及免於電擊/衝擊意外之外殼配線箱內。另必須具備保護措施 (如：特殊之工具或鑰匙才可打開) 防止非維護人員操作或意外衝擊本體，造成危險及損壞。如果以製造商未指定的方式使用設備，則可能會削弱設備提供的保護能力，若有維修或保養需求請與我們聯繫。

CN 本机为开放型 (OPEN TYPE) 机种，因此使用者使用本机时，必须将其安装于具防尘、防潮及免于电击/冲击意外的外壳配线箱内。另必须具备保护措施 (如：特殊的工具或钥匙才可打开) 防止非维护人员操作或意外冲击本体，造成危险及损坏。如果以制造商未指定的方式使用设备，则可能会削弱设备提供的保护能力，若有维修或保养需求请与我们联系。



EN Please refer to the AS Series Hardware and Operation Manual for more information

TR Daha fazla bilgi için lütfen AS Serisi Donanım ve Kullanım Klavuzuna bakınız.

TW 詳細資料請參考 AS 系列硬體及操作手冊

CN 详细资料请参考 AS 系列硬件及操作手冊

EN Assembly

TR Montaj

TW 安裝

CN 組裝

EN Clip up the two DIN rail clip on the module. Parallel the module groove on the back to the DIN rail, then push and slide along until hearing a click.

TR Modül üzerindeki iki DIN ray klipsini dışa doğru çekin. Altındaki modül oyuğunu DIN ray ile paralel konuma getiriniz ve sonra klik sesini duyana kadar klipsleri içe doğru bastırın.

TW 將模組上下方的兩個 DIN 軌固定扣往中間壓後，將模組後方勾槽平行對準 DIN 軌並往 DIN 軌壓直到喀一聲，即完成。

CN 将模块上下方的两个 DIN 轨固定扣往中间压后，将模块后方勾槽平行对准 DIN 轨并往 DIN 轨压直到喀一声，即完成。

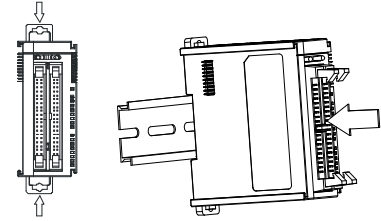

EN Input

TR Girişler

TW 輸入

CN 輸入

EN Input type: ① SINK ② SOURCE

TR Giriş Tipi: ① SINK ② SOURCE

TW 輸入接線：① 漏型輸入方式 ② 源型輸入方式

CN 輸入接線：① 漏型輸入方式 ② 源型輸入方式

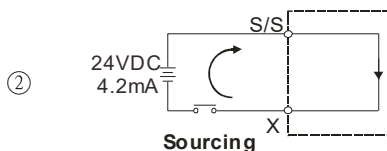
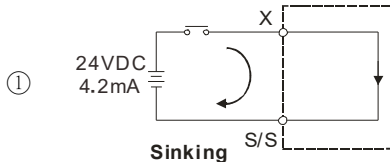

		2.0	2.1
-	-	2.2	2.3
1.15	1.14	2.4	2.5
1.13	1.12	2.6	2.7
1.11	1.10	2.8	2.9
1.9	1.8	2.10	2.11
1.7	1.6	2.12	2.13
1.5	1.4	2.14	2.15
1.3	1.2	S/S	S/S
1.1	1.0	-	-
-	-	3.0	3.1
S/S	S/S	3.2	3.3
0.15	0.14	3.4	3.5
0.13	0.12	3.6	3.7
0.11	0.10	3.8	3.9
0.9	0.8	3.10	3.11
0.7	0.6	3.12	3.13
0.5	0.4	3.14	3.15
0.3	0.2	S/S	S/S
0.1	0.0	-	-

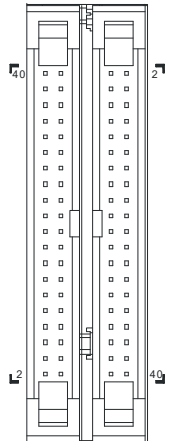

EN Dimensions(mm) & Product Profile

TR Ölçüler(mm) & Ürün Görünüşü

TW 尺寸 (mm) 及產品外觀

CN 尺寸 (mm) 及產品外觀

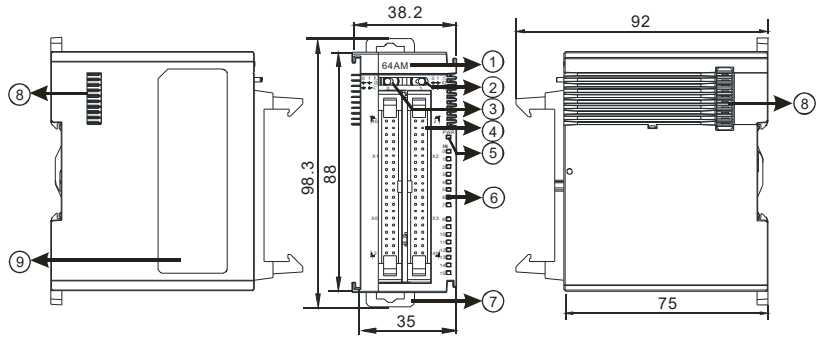

	EN	TR	TW	CN
1	Model name	Model adı	機種名稱	机种名称
2	LED switch 1	LED anahtarı 1	LED 開關 1	LED 开关 1
3	LED switch 0	LED anahtarı 0	LED 開關 0	LED 开关 0
4	MIL connector	MIL konektör	牛角座連接器	牛角座连接器
5	Power indicator	Besleme göstergesi	電源指示燈	电源指示灯
6	Input LED indicator	Girişler LED göstergesi	輸入指示燈	输入指示灯
7	DIN rail clip	DIN ray klipsi	DIN 軌固定扣	DIN 轨固定扣
8	Extension module communication port	Genişleme modülü iletişim portu	擴充模組通訊埠	扩充模块通讯端口
9	Label	Etiket	標籤	标签

EN Wiring	TR Bağlantı	TW 配線	CN 配线
-----------	-------------	-------	-------

EN I/O extension cable UC-ET010-24B / UC-ET020-24B / UC-ET030-24B

External terminal module UB-10-ID32A(mm)

TR I/O ilave kablosu UC-ET010-24B / UC-ET020-24B / UC-ET030-24B

Harici terminal modülü UB-10-ID32A(mm)

TW I/O 連接線 UC-ET010-24B / UC-ET020-24B / UC-ET030-24B

I/O 配線模組 UB-10-ID32A(mm)

CN I/O 连接线 UC-ET010-24B / UC-ET020-24B / UC-ET030-24B

I/O 配线模块 UB-10-ID32A(mm)

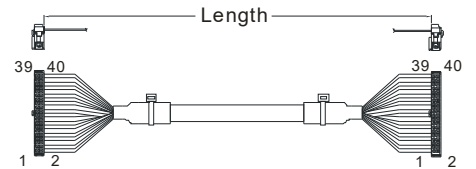

Length:
UC-ET010-24B(1M)
UC-ET020-24B(2M)
UC-ET030-24B(3M)

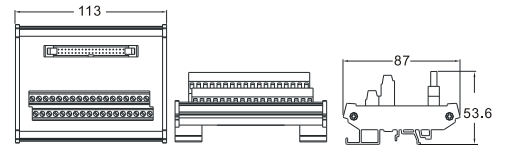

Part Name	有毒物质-Hazardous Substances						台達電子工業股份有限公司		Industrial Automation Headquarters							
	鉛 (Pb)	汞 (Hg)	鎘 (Cd)	六价铬 (Cr VI)	多溴联苯 (PBB)	多溴二苯醚 (PBDE)	機電事業群		Delta Electronics, Inc.							
金属部件 Metal Part	X	O	O	O	O	O	地址: 330477 桃園市桃園區興隆路 18 號 電話: 886-3-3626301 傳真: 886-3-3716301		Taoyuan Technology Center No.18, Xinglong Rd., Taoyuan District, Taoyuan City, 330477, Taiwan TEL: 886-3-362-6301 / FAX: 886-3-371-6301							
塑料部件 Plastic Part	O	O	O	O	O	O	中达电通股份有限公司		Delta Greentech (China) Co., Ltd.							
电子元件 Electronic	X	O	O	O	O	O	地址: 上海市浦东新区民夏路 238 号 邮编: 201209 电话: (021) 5863-5678 传真: (021) 5863-0003		238 Min-Xia Road, Pudong District, Shanghai, P.R.C. 201209 TEL: 86-21-5863-5678 / FAX: 86-21-5863-0003							
触点 Contacts	O	O	X	O	O	O	上海总部 电话:(021)6861-9090		南京	杭州	长春					
线缆和线缆附件 Cable & Cabling accessories	X	O	O	O	O	O	上海浦东 电话:(021)6301-2827	北京	武汉	福州	哈尔滨					
电池 Battery	O	O	O	O	O	O	南昌 电话:(0791)8625-5010	合肥	郑州	昆明	兰州	青岛				
本表格依据 SJ/T 11364 的规定编制。 O: 表示该有害物质在该部件所有均质材料中的含量均在 GB/T 26572 规定的限量要求以下。 X: 表示该有害物质至少在该部件的某一均质材料中的含量超出 GB/T 26572 规定的限量要求。							厦門 电话:(0592)5313-601		广州	南宁	贵阳	太原	无锡			
This table is made according to SJ/T 11364. O: Indicates that the concentration of hazardous substance in all of the homogeneous materials for this part is below the limit as stipulated in GB/T 26572. X: Indicates that concentration of hazardous substance in at least one of the homogeneous materials used for this part is above the limit as stipulated in GB/T 26572.							成都 电话:(028)8434-2075		西安	呼和浩特	太原	青岛				
							石家庄 电话:(0311)8666-7337		济南	天津	沈阳	无锡				
							重庆 电话:(023)8806-0306		西安	呼和浩特	太原	青岛				
							郑州 电话:(0371)6384-2772		西安	呼和浩特	太原	青岛				
							* 本手册内容若有变更, 恕不另行通知。		* 本手册内容若有变动, 恕不另行通知。							
Asia China: Delta Electronics (Shanghai) Co., Ltd. No.182 Minyu Rd., Pudong Shanghai, P.R.C. Post code: 201209 TEL: +86-21-6872-3988 / FAX: +86-21-6872-3996 Customer Service: 400-920-9595 Korea: Delta Electronics (Korea), Inc. 1511, 219, Gassan Digital 1-Ro., Geumcheon-gu, Seoul, 08501 South Korea TEL: +82-2-515-5305 / FAX: +82-2-515-5302 Singapore: Delta Energy Systems (Singapore) Pte Ltd. 4 Kaki Bukit Avenue 1, #05-04, Singapore 417939 TEL: +65-6747-5155 / FAX: +65-6744-9228 India: Delta Electronics (India) Pvt. Ltd. Plot No.43, Sector 35, HSIDC Gurgaon, PIN 122001, Haryana, India TEL: +91-124-4874900 / FAX: +91-124-4874945							Thailand: Delta Electronics (Thailand) PCL 909 Soi 9, Moo 4, Bangpoo Industrial Estate (E.P.Z), Pattana 1 Rd., T.Phraksa, A.Muang, Samutprakarn 10280, Thailand TEL: +66-2709-2800 / FAX: +66-2709-2627 Australia: Delta Electronics (Australia) Pty Ltd. Unit 2, Building A, 18-24 Ricketts Road, Mount Waverley, Victoria 3149 Australia Mail: IA.au@deltaww.com TEL: +61-1300-335-823 / +61-3-9543-3720 Americas USA: Delta Electronics (Americas) Ltd. 5101 Davis Drive, Research Triangle Park, NC 27709, U.S.A. TEL: +1-919-767-3813 Brazil: Delta Electronics Brazil Ltd. Estrada Velha Rio-São Paulo, 5300 Engenário de Melo - São José dos Campos CEP:12247-004-SP- Brazil TEL: +55-12-3932-2300 / FAX: +55-12-3932-237 Mexico: Delta Electronics International Mexico S.A. de C.V. Gustavo Baz No. 309 Edificio E PB 103 Colonia La Loma, CP 54060 Tlalnepantla, Estado de México TEL: +52-55-3603-9200		EMEA EMEA Headquarters: Delta Electronics (Netherlands) B.V. Sales: Sales.IA.EMEA@deltaww.com Marketing: Marketing.IA.EMEA@deltaww.com Technical Support: iatechnicalsupport@deltaww.com Customer Support: Customer-Support@deltaww.com Service: Service.IA.emea@deltaww.com TEL: +31(0)40 800 3900 BENELUX: Delta Electronics (Netherlands) B.V. Automotive Campus 260, 5708 JZ Helmond, The Netherlands Mail: Sales.IA.Benelux@deltaww.com TEL: +31(0)40 800 3900 DACH: Delta Electronics (Netherlands) B.V. Coesterweg 45, D-59494 Soest, Germany Mail: Sales.IA.DACH@deltaww.com TEL: +49 2921 987 238 France: Delta Electronics (France) S.A. ZI du bois Chaland 2, 15 rue des Pyrénées, Lisées, 91090 Evry Cedex, France Mail: Sales.IA.FR@deltaww.com TEL: +33(0)1 69 77 82 60 UK: Delta Electronics Europe Ltd. 1 Redwood Court, East Kilbride, Glasgow, G74 5PF, United Kingdom TEL: +44-1355-588-888		Iberia: Delta Electronics Solutions (Spain) S.L.U Ctra. De Villaverde a Vallecas, 265 1º Dcha Ed. Hormigueros - P.I. de Vallecas 28031 Madrid TEL: +34(0)91 223 74 20 Carrer Llacuna 166, 08018 Barcelona, Spain Mail: Sales.IA.Iberia@deltaww.com Italy: Delta Electronics (Italy) S.r.l. Via Meda 2-22060 Novedrate(CO) Piazza Grazioli 18 00186 Roma Italy Mail: Sales.IA.Italy@deltaww.com TEL: +39 039 8900366 Turkey: Delta Greentech Elektronik San. Ltd. Sti. (Turkey) Serifali Mah. Hendem Cad. Kule Sok. No:16-A 34775 Ümraniye - Istanbul Mail: Sales.IA.Turkey@deltaww.com TEL: +90 216 499 9910 MEA: Ettek Dubai (Ettek MEA DMCC) OFFICE 2504, 25th Floor, SABA Tower 1, Jumeirah Lakes Towers, Dubai, UAE Mail: Sales.IA.MEA@deltaww.com TEL: +971(0)4 2690148					

*We reserve the right to change the information in this instruction sheet without prior notice.